



!"#\$ %&(')*+,-
./012 34567 899:56 9 55 ;<=>? 34567 899:56 9 5@
ABBC DDD E>?FGHI IFE IG J:E>H2 HGKFLE>?FGHI IFE IG
M+NO ABBC B PP IFE E>?FGHI
QNO ABBC D1HRF IFE E>?FGHI





STUVWX

! " # \$ %

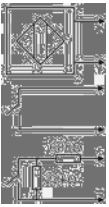

*+YZ[\]^_`

&'# ()* + , - . ++ - .

abcd	abe fg	fg	g	hij	klmn opq	rs	tu
	Xvwxy z{)~ X• E €•,0fe	...†† .%Š €•,0f	=: :CE(•: :CE =: :CE(•: :CE =: :CE(•: :CE	Ž ~ X• Ž ~ Ž ~	E €•,0fe }Ž• (• •	CE(• 6 6	9
	X• E €•,0fe }Ž•xy "um	•-†. -~%Š €•,0f	=: :CE(•: :CE =: :CE(•: :CE =: :CE(•: :CE	Ž ~ ~•) Ž ~ Ž ~	X• E €•,0fe	CE(• 5 5	8
	™š;œ•ž ™s)-~œ e	...†† œŸ% Š	=: :CE(•: :CE =: :CE(•: :CE =: :CE(•: :CE	Ž ~ i, ø) Ž ~ Ž ~	£se } }Ž• (• }Ž• (•	CE(• @: @: }~¤ @: ¥ CE(•	@: @: @: @: @:
	LX9E }Ž•.† •S	•-†† œŸ% Š	=: :CE(•: :CE =: :CE(•: :CE	Ž ~ ~•) Ž ~	X .@e	CE(•	

/*0123

45678

ª = : < :CE(•: :CE
= = k«-Y)-†@
< †.ˆ %Š-ˆ°•,0
CE(• ±y²³´µ%¶
Ž ~
Ž ~
Ž ~
CE . , -€¹º,»œ¼½f

9:;<

¼¿ÀÁ 5 E E 8 5EE
ÂÃÄÅ 9 Ä
ÆÁÇÈ 9É=CE Ê
ËĜĤ 9É=CEL 9Ê
ÏÆĪ- : •6 Ê
Ī-Đ • Ä

/*01=>

.ĐÑÒ .ĐÓ™ÑÒ

.†°Ö ÖÖ †JÁ 6 6: x†JÁ 6 6: : x

ØÙ 0 5 65

Ú. ÛÜŸ.-5P ß ™ŸŸ. XP

àáâ .Đv: -† ße v : -P

Qã . • v.6(†)-3.3(5 TD -.03.020 [(ââ)-11.8(â)-11-7.6(†)-ââ -1.76(°)]5828 :)6.5 TD7201 æD .0086 Tc [(CE)9.

5 6

78 +9;< =>?@% A0>B' C

DEF%G = HI@%'

0 9

0	+,J KL	56	MN-O 4
	*PL	Q)
	*PL)	3 Q)
	*PL	Q)
	*PL)	3 Q)
	*PL	Q)
	*PL)	3 Q)
	*PL	Q)
	*PL)	3 Q)
	*PL	Q)
	*PL)	3 Q)
	*PL	Q)
	*PL)	3 Q)

&

R *

5 6

S TU V W.X%D

0

0	MN-	4

J K LMNOP !"QR S

T + +U ,++V

íîûø vw• vwxyz{| Ì-Đ- z{|)-ø.-e €°•,0f ~
 ~%oT)-• ÁCE •Áæ o X vwz{|)-ø.-e ~%oæ %¶'ñ ~. ~.Đx
 }Žx)- ~%oæ ° Ž -æ
 %¶ (JÁ6 9 5 ~ o CE• ø²³cdkl-²³ }-e 6E •
 , E æ
)*

vw• vw•X vwxyz{|xêxyz{|-X• E 4•,0e

4

g	ž	ž	}-	}-	
= : :CE• :CE X• E 4•,0	p	X• E 4•,0	p		

0123 ÁÄÄÄ }Ž:)-~ 9 Á€ EHGf
 Ì-Đ Á-± 6 }Ž:Đ- 9 Á€ EHGf
 }Že ím- X vw- X E 4•,0 }-:Đ- 9 Á€ EHGf
 ‡. 6 6- ¶. ÁÄ. }Ž:)-:Đ- €9 Áf
 ‡.ÑÖ ,)-→X E WX23
 \$). -6 òè J?H> Ø> Á
 }Ž -)Ž- 9 'µ j €†@ 8:5f
 }-e ²³m-X E 4•,0 E 9 F 5 ‹F @ E
 }- •9 -o •,0 F 69 E ÁF 9G= •F XE•
 ÌÍL 9Ê É=CE€ ‹F B f 'µ j €†@ @: f
 ÆÁÇÈ 9É=CE Ê E 9 F 9 ‹F E
 n E F 89E ÁF 8 = •F E•
 .Û~%o }Ž:Đ-}Ž:)-~ 89 ?@Y Z [\ -J^`

)*abY



J K LMNOP !"QR S

T + +U ,++V

íîûø vw• vwxyz{| Ì-Đ- z{|)-ø.-e €°•,0f ~
 ~%oT)-• ÁCE •Áæ o X vwz{|)-ø.-e ~%oæ %¶'ñ ~. ~.Đx
 }Žx)- ~%oæ ° Ž -x Ž -æ
 %¶ (JÁ6 9 5 ~ o CE• ø²³cdkl-²³ }-e 6E •
 , E æ
)*

vw• vw•X vwxyz{|xêxyz{|-X• E 4•,0e

4

g	ž	ž	}-	}-	
= : :CE• :CE X• E 4•,0	p	X• E 4•,0	X• E 4•,0	X• E 4•,0	
= : :CE• :CE X• E 4•,0	X• E 4•,0	X• E 4•,0	X• E 4•,0	X• E 4•,0	

0123 ÁÄÄÄ }Ž:)-~ 9 Á€ EHGf
 Ì-Đ Á-± 6 hi }Ž:Đ- 9 Á€ EHGf
 }Že ím- X vw- X E 4•,0 }-:Đ- 9 Á€ EHGf
 ‡. 6 6- ¶. ÁÄ. }Ž:)-:Đ- €9 Áf
 ‡.ÑÖ ,)-→X E WX23
 \$). -6 òè J?H> Ø> Á
 }Ž -)Ž- 9 'µ j €†@ : x X: 9f
 }-e ²³m-X E 4•,0 E 9 F 5 ‹F @ E
 }- •9 -o •,0 F 69 E ÁF 9G= •F XE•
 ÌÍL 9Ê É=CE€ ‹F B f 'µ j €†@ : x 9: f
 ÆÁÇÈ 9É=CE Ê E 9 F 9 ‹F E
 n E F 89E ÁF 8 = •F E•
 .Û~%o }Ž:Đ-}Ž:)-~ 89 ?@Y Z [\ -J^`

)*abY



J K cBNfgh !"

. { T e

™ ÁCE •Á ø'æe - ~%oT- ïbùø ²,!'•\$~|~)± LX9E æ
 %¶'ñ .-.Ðx)Žx)- ~%oæ%¶])- ~)) ,)...±yæ ° Ž -æ
 %¶ (JÁ6 9 5 - o CE• ø²³cdkl-²³ }- .æ

)*

²,!'- ²\$~|

4

g	ž	ž	~	~
=:~:CE•:CE \$.©	p	~ LX9E	p

0123 ìe }-€²³mf ç £s)-
 ,æ. Á Á
 .- E 9 E
 ũæ • 8 5 †@m-•= ›h
 .Û~%o }-:Ð-ž:}-~ 89
 ÁÁÁÁ ž:}-~ 9 Á€EHGf
 }-:Ð- 9 Á€EHGf
 ž:}-:Ð- 9 Á€EHGf
 ÁÁ. ž:}-:Ð- €9 Áf
 WX23
 òè J?H> Ø> Á
 'µ j €†@ 8:5f
 E 9 F 5 ‹F E
 F 88 E ÁF 9 G= •F E•
 ?@Y Z [\ -]J^_`
 J?H> Ø> Á
 'µ j €†@ : x X: 9f
 E 9 F 5 ‹F E
 F 88 E ÁF 9 G= •F E•
 ?@Y Z [\ -]J^_`
 J?H> Ø> Á
 'µ j €†@ : x X: 9f
 E 9 F 5 ‹F E
 F 88 E ÁF 9 G= •F E•
 ?@Y Z [\ -]J^_`

)*abY



J K cBNfgh !"

. { T e

™ ÁCE •Á ø'æe - ~%oT- ïbùø ²,!'•\$~|~)± LX9E æ
 %¶'ñ .-.Ðx)Žx)- ~%oæ%¶])- ~)) ,)...±yæ ° Ž -æ
 %¶ (JÁ6 9 5 - o CE• ø²³cdkl-²³ }- .æ

)*

²,!'- ²\$~|

4

g	ž	ž	~	~
=:~:CE•:CE \$.©	\$.©	~ LX9E	~ LX9E

0123 ç•J }-~ ~ ß
 -)žv)
 ũæ • : †@m-•= ›h
 .Û~%o }-:Ð-ž:}-~ 89
 ÁÁÁÁ ž:}-~ 9 Á€EHGf
 }-:Ð- 9 Á€EHGf
 ž:}-:Ð- 9 Á€EHGf
 ÁÁ. ž:}-:Ð- €9 Áf
 WX23
 òè J?H> Ø> Á
 'µ j €†@ : x X: 9f
 E 9 F 5 ‹F E
 F 88 E ÁF 9 G= •F E•
 ?@Y Z [\ -]J^_`
 J?H> Ø> Á
 'µ j €†@ : x X: 9f
 E 9 F 5 ‹F E
 F 88 E ÁF 9 G= •F E•
 ?@Y Z [\ -]J^_`
 J?H> Ø> Á
 'µ j €†@ : x X: 9f
 E 9 F 5 ‹F E
 F 88 E ÁF 9 G= •F E•
 ?@Y Z [\ -]J^_`

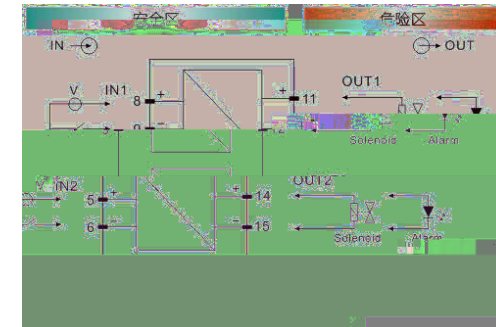
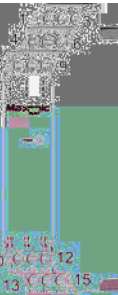

?@Q S}}

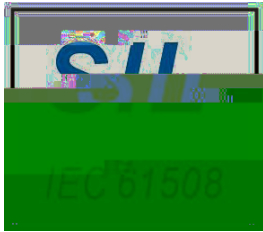

?@
 CE•€CE>KB <GB1 HB•1 12f'µ <JÁ6 9 5->JÁ6 9 -
 <JÁ 5X@: è - 23 ø23 Ô €CE•f x
 µ 'æ±y23'µ ñ 23) — ø
 - ½ Ô x ½ xið xJ Á.:f°Ô...
 ° æ

u ~•
 <JÁ 6 9 : ýñ ò o 23cdkl€CE•fýø n
 <JÁ6 9 5 øñò- ñòø23 Ô €CE•f ø'µæ
 è <JÁ6 9 99: 9 ýø o µ HF 1 øñ

òæ23Š ±y23klø¥ æCE•CE ø23 Ô CE•CE klø ø CE•
 "ø CE•) CE•; |4 CE••23»æø¥ 4CE• 4CE•

€ •,

23±y ø±yæ23±yø-o íí ½ ø í • TM
 ø Á- Ñµ Z 23 æCE• CE•CE "ø ù - ùñòø23
 ±yøý ød æCE• %ø ø - \$-CE•CE óy ùñòø23±yø æCE•
 'µ X -CE••CE•X- ý-CE•X \$æ
 d 23 Ô - - ‡ J J J 23»æklø23±y è Ý

CE•	€ ñò	ñò- - ±yñòø@	= > f	\$ñò- - -	íí	=*f
X		:9 = > :X		:@ =• :5		
		:X = > :		:5 =• :8		
		: = > :		:8 =• :6		
		: = > :		:6 =• :9		

?@f...t&u†f,,

x ±y23 ÷kø Ñ J J J 23»ækly • Ñ ùñòø±y2
 3- ù ø • 3 ø • ø ñÖÖ ØÙ 0 X 5
 <JÁ 6 9 5 ù "øñòæ
 xCE• ø " - Ñ ½ y23noß = J - klø
 |½ -klø@ ß=0 Ž... - µ = J
 ø Ô- "CE• æ
 x Öy ið nOø ØÙ 5 6 6 9 5 øñò- %¶ øg- ß±
 y23%¶ ÖÖ ±y23»æø.í°è <JÁ6 6: : øñò- „ ... ø Á
 ñ\$ hc ò.ø%¶ J Á Öyøñòæ

P%Š(WXCE•}}

x Īx xw x Ü %
 ý- ø -a]ððÖ øíí b ù-
 bù øø.Ü]æððÖí
 ð øø è æ
 XŽ••'uo'to,€o"

XŽ••'uo'to,€o"

23 ðklø ø%¶ø°gý-
 1ñ ððÖíðý øÜ÷ x
 ¼- n ððÖÜ÷-æøá Á
 ððÖÜ÷ííbù #
 # s n m

d Ô	÷k ý <JÁ ØÙ 5 6 <JÁ6 8@: J 9 X	s rÔ
	Á	
Ü	Á	
	Ü	
	3 7	
.Ô	Á	
è . Ô	Ü	
Ô		

"P%Š(u...TMŠ"p

ðè ØÙ 5 6 ø]æ "-
 .Ü øÆÁ \$d ÆÁø
 øÜ÷ ÆÁøæek

ÆÁ	\$d ÆÁ	.Ü23Öy
0	X9 Ê	↓ \$
0	Ê	
0	Ê	
0X	9Ê	
09	Ê	
06	59Ê	

• "£g|}

²g²³Šno ² öklø ý¬
² ²³bù ™ Ýíí#øe } ~ ²
³e •²³#•íí#æ.)ýh ^— ^

"WX¹⁰» ¼

x²³Šn²

²³bú⁻²

" ó]Ă ø

xá ı

Ye †x.Đ†

Ů