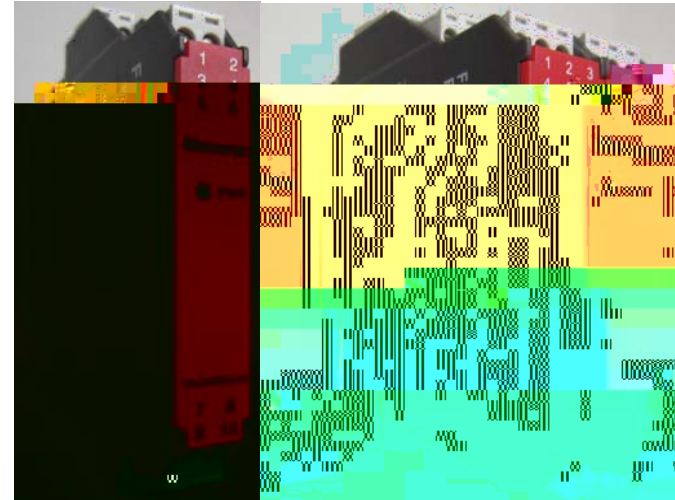

Maxonic 万讯

SHENZHEN MAXONIC AUTOMATION CONTROL CO., LTD

!!! " # \$!!!

%%! !

& ! ! ' ((



Maxonic 万讯



9;;1

!

45

247 3:4

((

*

(+(4 4	!*	(!*	
(+(4 2	!*		7+@A !*	

<=

B" 8 C 4

#

< F

;D . ;D . +D
3D (= 4D :D ' ,

* F

7+@A ' ,

;D . ;D (. +D(
3D = 4D E :D ,

\$ < (6 7 %& +E <(E

< 6 7

.24 <(=

(. ! F

> .4 (

> .4 (

> .4 (

> 5F .24

* +

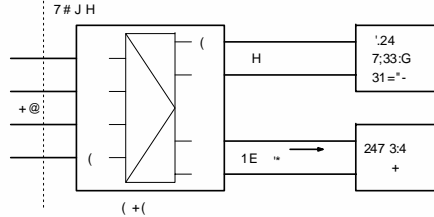
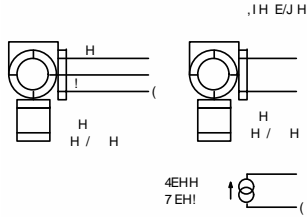
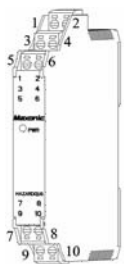

9;;1

!

45

247 3:4

((

*

(+(4 4 13(!*	(!*	
(+(4 2 13(!*		7+@A !*	

<=

B" 8 C 4

#

< F

;D . ;D . +D
3D (= 4 D :D ' ,

* F

7+@A ' ,

;D . ;D (. +D(
3D = 4D E :D ,

\$ < (6 7 %& +E <(E

< 6 7

.24 <(=

(. ! F

> .4 (

> .4 (

> .4 (

> 5F .24

* +

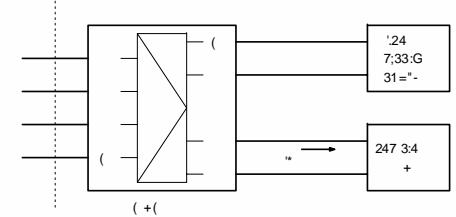
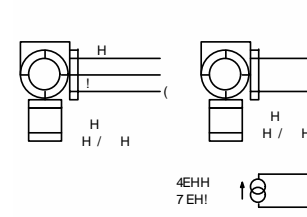

9:;:1

>?@A

45

247 3:4

(+(4 4 7=(* ((*	
(+(4 44 7=(* ((*	*
(+(4 2 7=(* ((7+@A *	
(+(4 22 7=(* ((7+@A *	7+@A *

<=

B" 8 C 4

* F

7+@A'

;D . ;D . + D ' ,
3 D (= 4 D :D

\$ (* .24
\$ < (6 7 %& +E <(E
< 6 7

.24 <(=

(! F

> . 4 ()
> .4 ()
> .4 ()

> 5F . 24

< F

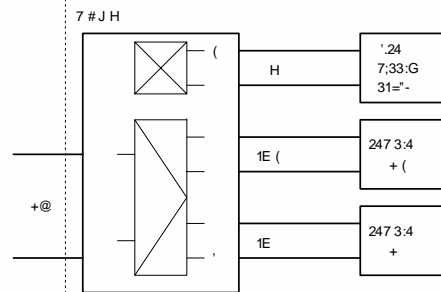
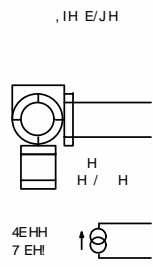
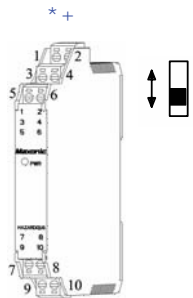

9:;:1

!

45

247 3:4

(*	(*	*
+(4 44	* ((*	*
+(4444	* ((*	*
+(4 22	* ((7+@A '* 7+@A '*	
+(4422	* ((7+@A '* 7+@A '*	

<=

B" 8 C 4

#

< F

((('(
;D . ;D . + D ' ,
3 D (= 4 D :D

* F

7+@A'

((('(
;D . ;D . + D (' ,
3 D = 4 D E :D

\$ (* .24
\$ < (6 7 %& +E <(E
< 6 7

.24 <' =

(! F

> .4 ()
> .4 ()
> .4 ()

> 5F .24

* +

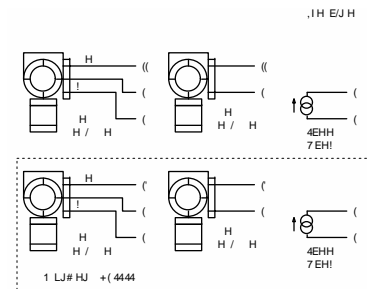
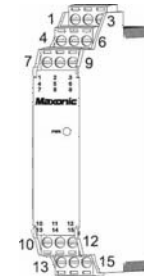

.1H E/JH

7#JH

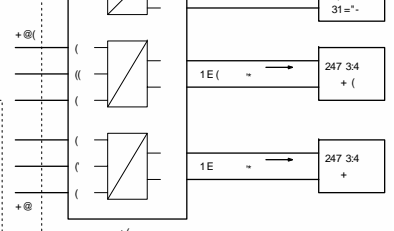

9:;,1

!

45

ò ý@ÖÀ Z[I Z[*iH]^ W@~+qf \]^_`À+aA f cd4
 g 247 3:4 ç èM ' Z[\]^`À+aA cdç "ß£ ' +cdCçèÿ (e `š
 e `ç

Z[I Z[I ' Z[*iH]^f * A

C	_e (_e	_` (_`
+(4 44 13(''	p	''	''
+(4444 13('' ''	''	''	''
+(4 22 13(''	p	7+@A ''	7+@A ''
+(4422 13('' ''	7+@A ''	7+@A ''	

<=

Ò B 8 C 4
 j— (((š (' (k
 ;D . ;D . +D
 3D (= 4D :D ' ,
 j— ((š ((k
 ;D . ;D (+D(
 3D = 4D E :D ,

@~+q à .24 fG <=
 _eA ýKf ' Z[f ' à
 b++é (à . f

" 9:11 B # C
!"

\$ 9:,DE

%

%

45

/0

247 3:4

5.

	((
+)))) 6) 6) 6

(*.24	*(24	* .' 789
*.24 9	* 24 G	:
(* .24 4	* 24 8	; < =>?
' *(.24 M	* .	

@

('* (*. * (A + 4'

BC + 4444 * E +(4444

<=

B" 8 C 4

((('(

; D . ; D((. + D(' 3 D = 4 D('E :D ,

.24 <=

F5.

<(F

>(0F

F 5 .

F",1G

%

45

- 247 3:4

((

* *

(1(44	*	(*	
--------	---	---	---	--

< =

B" 8C 4

* F

\$ < (6 7 %& +E<(E

;D . ;D . +D
3D (= 4D :D ',

< 6 7

G *H /

.24 <(=

> .4 (

> .4 (

> .4 (

< F

> 5F .24

* +

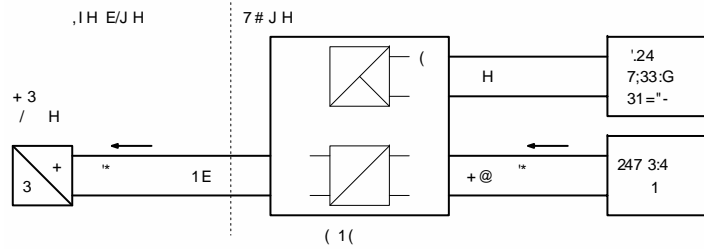

F",1G

%

45

- 247 3:4

((

* *

(1(44	3(*	(*
--------	----	---	---	---



F",1G

%

45

- 247 3:4

(

* *

	((
1(4 44	*		* *	*
1(4444	*	* *	* *	

< =

B" 8 C 4 * F
 ((((' \$ < (6 7 %& +E <(E
 ;D . ;D +D
 3D (= 4D :D ',
 G *H /

. 24 < =

> .4 (

> .4 (

< F

> .4 (

> 5F .24

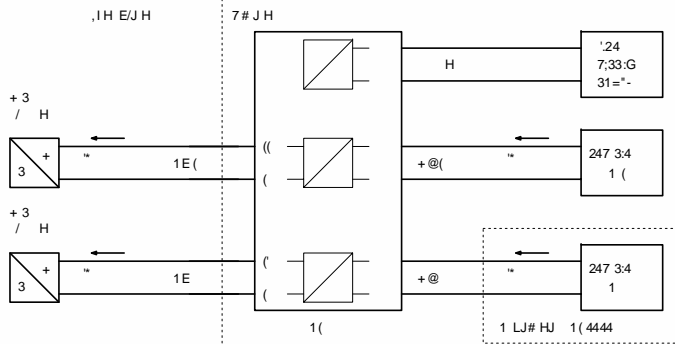

F",1G

%

45

- 247 3:4

(

* *

	((
1(4 44 13(*		* *	*
1(4444 13(*	* *	* *	

< =

B" 8 C 4 * F
 ((((' \$ < (6 7 %& +E <(E
 ;D . ;D +D
 3D (= 4D :D ',
 G *H /

. 24 < =

> .4 (

> .4 (

< F

> .4 (

> 5F .24

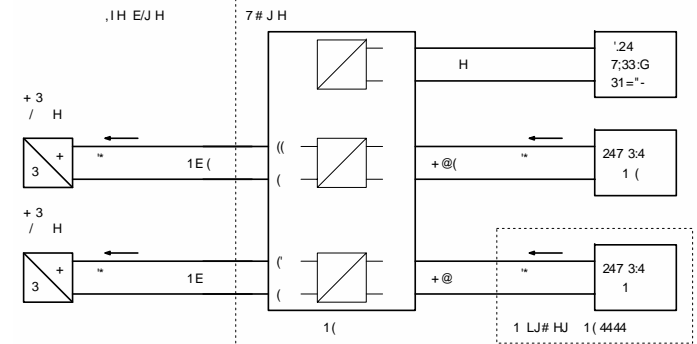
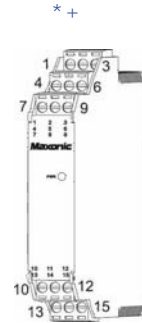

" F",1G B # C
 %

45

- 247 3:4

M " ((

* , -

(1 44	*	, -		

< =

B" 8 C 4

(* F , - * , > F

< N >(0 N

O ' ,

;D . ;D . +D
 3D (= 4D :D ' ,

\$ < (6 7 %& +E <(E

< 6 7

G *H /

.24 < =

< F

> .4 (

> .4 (

> .4 (

> 5F .24

* +

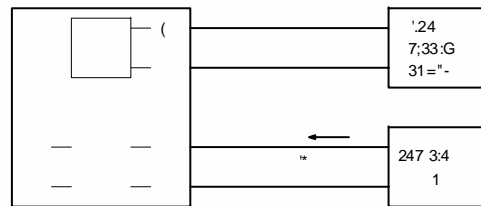

(1

\$ F",DE
% %

45

- 247 3:4 . /0
(((

5.

	((
(1))) 6) 6) 6

(*.24 ' 4	* (.24 4	* 24
* .24	*(24 8	; < => ?
(* .24 9	* 24	

@

(* (*(. A (1 4'
* ('* *(. A (1 44'
BC (1 44 *D E (1(44

<= * F
B" 8 C 4 >(0F

;D . ;D . +D (\$ < (6 7
3 D (= 4 D :D ', %& + E <(E . E < .
< 6 7

G *H /

.24 <(=

F5. > .4 (# < F > .4 (>(0F > .4 (F5. (> .4 (> 5F .24

* +

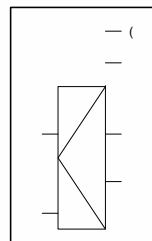

.24
7:33:G
31="



" & F",1G B # C
 %

45

- 247 3:4 , -
 I JK L B" & 8&C 4 (
 (

* , -

	((
(1' 4 4	*	, -	*	, -
(1' 4444	*	, - * , -	* , - * , -	

< = ,O . 24

B" & 8&C 4

(
 ;D . ;D +D
 3D' = 4D :D ,

' , -
) .

9:,@AH

"

45

/0

247 3:4 M

@ 5;-

	((
(2+((((

< =

B" 8 C 4

R : "2

R : "2

1@

V W

\$. 4 \$.24

XYZ[(\

< ,l

.24 < =

> (< 0F 1@

< (> (0F 1

> "

< (> .4 (

> .4 (

> .4 (

> 5F .2 4

.O(6

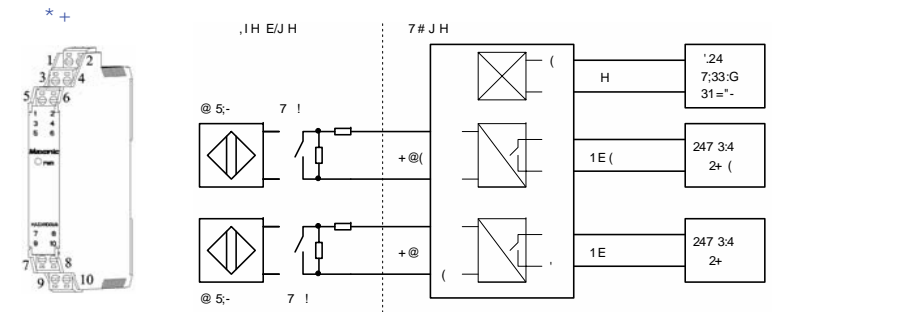

2+3	1@	1
7=((* ((] * (
7=	*] *
7=	`a (" "	`a (" "
7=!	`a " "	`a " "

9:,@AH

"

45

/0

247 3:4 M

@ 5;-

	((
2+((((VSW	VSW

< =

B" 8 C 4

F",@AH

' " %

45

- 247 3:4

M

e

((

(.\$

	((
(21(('			(.\$	
(21(' ']			(.\$	

<=

B" 8C 4

;D . ;D . +D
3 D (= 4D :D ',

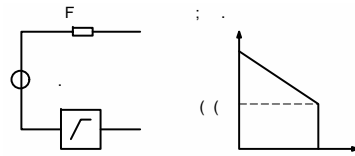

(.\$

.24 <(=]

j <(,l

R :2

SR :2

1@ TU

(

Im :2 ^

In :2 ^

> 1@
<(1
.O(6
" O(6

] ? \$'.24

(* . 1@

*. 1

" fg N

h iN

> .4 (

> .4 (

> .4 (

> 5F .24

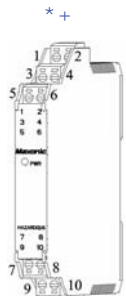

,IH E/J H

7# JH

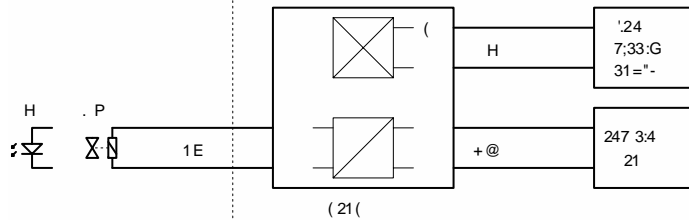

F",@AH

' " %

45

- 247 3:4

(.\$

M

"

e

	((
21((("	' ']	' ']	(.\$	(.\$

<=

B" 8C 4

;D . ;D . +D
3 D (= 4D :D ',

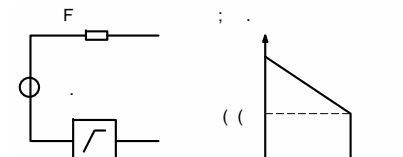

(.\$

.24 <(=]

j <(,l

R :2

SR :2

1@ TU

(

Im :2 ^

In :2 ^

> 1@
<(1
.O(6
" O(6

] ? \$'.24

(* . 1@

*. 1

" fg N

h iN

> .4 (

> .4 (

> .4 (

> 5F .24

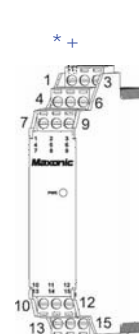

,IH E/J H

7# JH

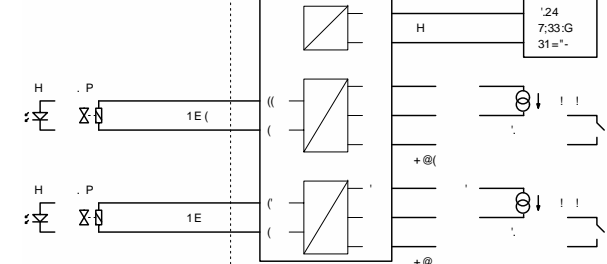

\$ F",@AH

' " %

45

- 247 3:4] e

JK ((

	((
21	(]
21	(()]

& F",@AH

' " %

45

- 247 3:4 e ((.\$
B" 8C 9 M " ((

	((
21' ('			((.\$	
21' '	!]		((.\$	

<=

B" 8C 9
(((
;D . ;D . +D(
3D('= 4D'E :D (,

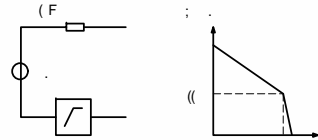

.24 <=]

j " fg N
h iN

> 1@
< 1

R : "2
R : "2 1@

.O(6
O 6

] ? \$'.24

(* . 1@
* . 1

> .4 (
> .4 (
> .4 (
> 5F

.2761 836.48 580.554 -410.505 re 587.83 836.48 m W* n 587.83 836.48 -580.554 -410.505 re W n BT /F1 1 Tf 0 -7.2061 7.2061 0 214.2661 594.93547374.9

IJKL

" %

MNO PQR

	\$		\$	
	\$	O w		
A	((6 7
7	(((6 7
"	((6 7
9	((((6 7
-	(((6 7
	'			(6 7
T	((6 7
@	((6 7
3 ((6 7

3 ((u t2†
 3 ((W (6D (~* 2 %Š
 3 (W (6D ~* 2 %Š

* +

IJKL

" %

MNO PQR

	\$		\$
	\$	O w	
A	((6 7
7	((6 7
"	((6 7
9	(((6 7
-	((6 7
	'		(6 7
T	((6 7
@	((6 7
3 ((6 7

3 ((u t2†
 3 ((W (6D (^* 2 %Š
 3 (W (6D ^* 2 %Š

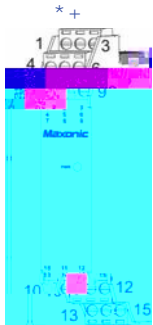

4T4 { } •• I' * ^
 <H +, Œ]} pA•Ž
 <H +, Œ ^_ u ^_•Ž

S\$TIKUV+ ") *
 45T 3(34 3() \$
 *+T

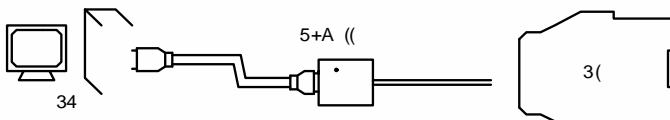

W1XO

"

45

- . 247 3:4 M)
* (

5 .

	((
3 ...	(.*(.		(.*(. (.*(.	
3	(.*(. (.*(. (.*(. (.*(.			

< =

\$ 1YO

45

[\ K L , !

45

- " . 247 3:4
l) \$ ((

† @ 5;- — @3@ 3@3

	((
(4(S)	S 6	() 6) 6

(—	8	<	=>?
---	---	---	---	-----

(*. 24	'	*(. 24 4	* 24	
*. 24		*(24 8	<	=>?
(* . 24 9		* 24 G		

@ (@ 5;- © * A (4((44
=>* \$ pAqr st u *(0,l
l) \$ => U vw 5+A ((V 3 U)4 H %E !L4 #KV

< = — (B" 8 C 4 * . *(.]

(' . (. \$
;D . ;D(. +D B (. \$. Tc 0re 026(.)5()TJ /F1 1 Tf47.8799 .0126 TD 0 Tc (k)Tj 0 -7.2061 7.2061 0 247.0006623.89725 Tm -.001 Tc (**Tj /F6 1 Tf 2.0056 0 TD 0 Tc (\$)Tj /F1 1 Tf .999 0 TD .0105 Tc Ø f(l(D
3 D = 4 D('E :D' ,

(
;D . ;D . +D
3 D = 4 D :D ' 5

(
;D . ; D(. +D
3 D = 4 D('E :D ,

. 24 <(=

(
> (< 0 F 1 @
< > (0 F 1

.O(6
" (O(6